

Enjoy
the
ride

User manual



KM529

POPAL

At Popal we make bicycles for daily use. Bikes that you can count on, and will never leave you out in the cold. For us, it's not just about the fastest route, but about the journey itself. The journey is where you can enjoy your favourite music, appreciate conversation or simply see the beauty around you. In short, moments that are important to you, are important to us and that's why we make sure you are able to rely on our bikes. No excuses here: we always make the best bicycles, for the best prices, with the care and love that our riders deserve.

Ready for your journey.

Care for your battery!

Our batteries are of high quality, but be aware, even very good batteries are vulnerable when misused. Make sure to read our tips to secure a long live cycle and to protect it against fatal deep discharging.

- Always charge your battery when nearly empty
- Switch the system off, if you're battery runs out of power during your ride
- Store your battery at room temperature and keep the charging level at 30%-70%
- Check the charging level once a month

For more tips and tricks or information regarding warranties and terms and conditions please visit: popal.com/klantenservice

KING-METER

USERS GUIDE

KM529



Contents

1	About the User Manual	1
2	Appearance and Size	2
3	Function Summary	3
4	Monitor Area	4
5	Operation Cautions	4
6	Installation Instruction	4
7	Normal Operation	4
7.1	Power On/Off	4
7.2	Speed Display (Real-time speed/Average speed/Max speed)	5
7.3	Turn on/off Backlight	5
7.4	Distance Display (Trip Distance/ Total Distance)	6
7.5	PAS Level Selection	6
7.6	Battery Indicator	7
7.7	Error Code Information	7
8	General Setting	9
8.1	Wheel Diameter Setting	9
8.2	Speed-limit Setting	9
8.3	Backlight Contrast	10
9	Connection layout	11
10	Barcode	12
11	FAQ	12
12	Quality assurance and warranty scope	13
13	Version changes	13

1. About the User Manual

Dear users,

To ensure better performance of your e-bike, please read through the KM29 product introduction carefully before using. We will use the most concise words to inform you of all the details (including the hardware installation, setting and normal operation use of the display) when using our display. Meanwhile, the introduction will also help you to solve the possible confusion and malfunctions.

2. Appearance and Size

KM529 products are made of PC. Under the temperature of -20 to 60°C, the shell material can ensure normal usage and good mechanical performance. Real product and dimension figure (unit: mm)

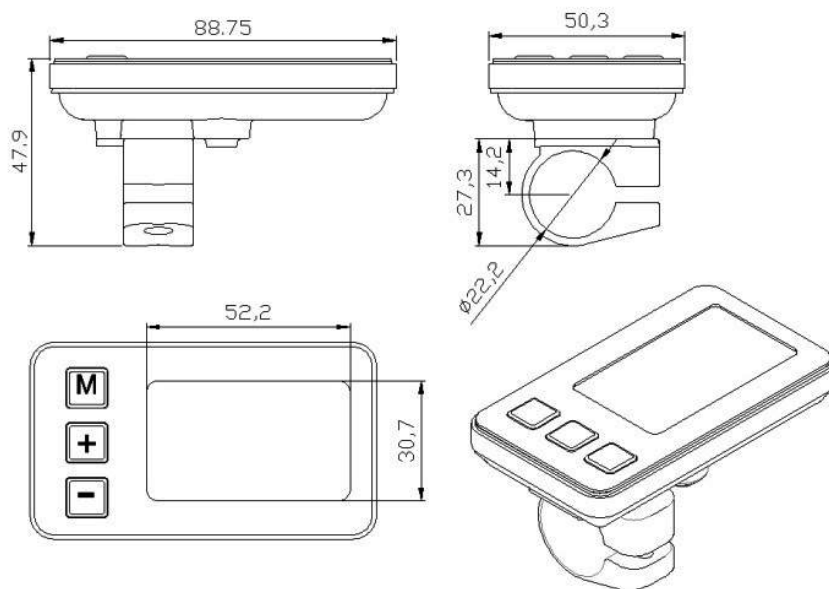

3. Function Summary

KM529 provides a wide range of functions and indicators to fit for users' needs. The indicated contents are as follow.

- ◆ Battery Indicator
- ◆ Speed Display (including real-time speed, average speed and max speed)
- ◆ Trip distance and total distance
- ◆ PAS Level Selection
- ◆ Headlight On/Off
- ◆ Error Code Indicator
- ◆ Various Parameters Setting, such as wheel size, speed-limited, backlight brightness and so on.

4. Monitor Area

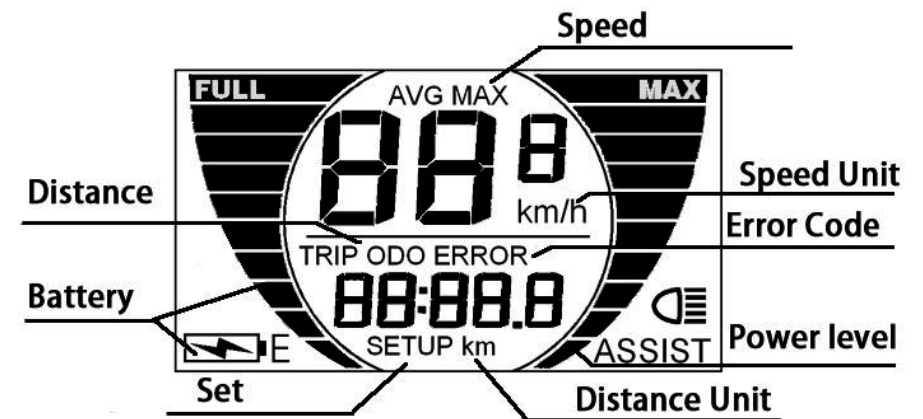

KM529 Monitor Area

5. Operation Cautions

Be care of the safety use. Don't attempt to release the connector when battery is power on.



Try to avoid hitting.



Try to avoid wetting.





Make the display repaired when it doesn't work normally.

6. Installation Instruction

Fix the display onto the handlebar and adjust to an appropriate visual angle. Tighten all the connectors.



7. Normal Operation

7.1 Power On/Off

Press Button  for 2 seconds then the display will power on, and the controller will power on at the same time. With display on, Press Button  for 2 seconds to turn off power system of the e-bike. With the display off, the display and controller shut down. The leakage current of display on shutdown state is less than 1μA

When the e-bike is without using for 10 minutes, the display will shut down itself automatically.

7.2 Speed Display (Real-time speed/Average speed/ Max speed)

After starting up the display, default show is real-time speed. Long press both  and  buttons for 2s to change the indicated information in sequence as below: Real-time Speed (Km/h) → Average Speed (Km/h) → Max Speed (Km/h).





Real-time speed

Average speed

Max speed

7.3 Distance Display (Trip Distance/ Total Distance)

After starting up the display, default show is Real-time speed. Press button  to change the indicated information in sequence as below: Trip Distance (km) → Total Distance (km). Long press the two buttons  and , the trip distance will be reset to zero.



Trip Distance (TRIP)



Total Distance(ODO)

7.4 Turn on/off Backlight

Press button **+** for 2 seconds to turn on the backlight of the display, the headlight will be on at the same time. Hold Button **+** for 2 seconds again, backlight is off.

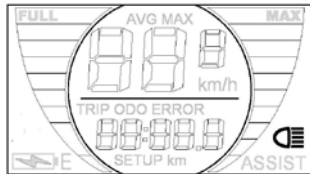

Turn On Backlight

7.5 PAS Level Selection

Press button **+** or button **-** to change the output power of the motor. The power ranges from level 1 to level 5. Level 1 is the minimum power. Level 5 is the maximum power. The default value is level 1.

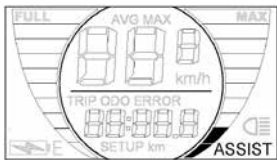

PAS Level 1

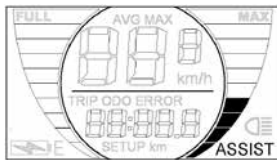

PAS Level 2

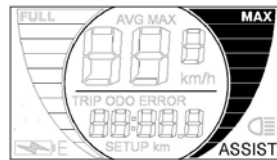

PAS Level 5

7.6 Battery Indicator

The display shows the battery capacity in 5 levels. When the battery is in high voltage, the word FULL will show on the top of screen. When the battery is under-voltage, the letter E will be shown on the bottom of screen and the LCD indicator will flash, please charge the battery.

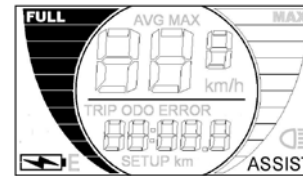

High voltage

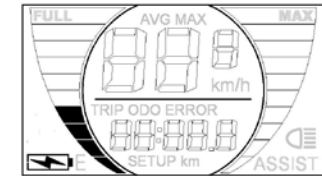

Low voltage

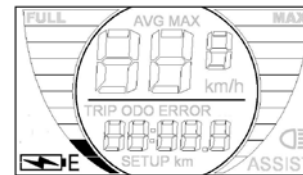

Under-voltage Flash

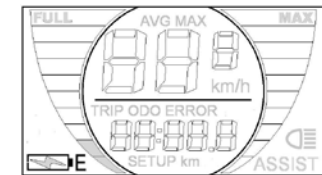

Battery indicator

7.7 Error Code Information

If there is something wrong with the electronic control system, the error code will appear automatically. When error appears, please check the corresponding part of e-bike or sent the

display to be repaired.



Error Code

Following is the detail information of error code:

Error Code	Definition	Solution
21	Current Abnormality	Inspect if motor phrases short-circuits
22	Throttle Abnormality	Inspect if throttle recover original state
23	Motor Abnormality	Inspect if motor phrase is well-connected; Inspect if lines are well-connected between motor phrases and controller.
24	Motor Hall Signal Abnormality	Non-Hall Controller: Inspect if motor phrase is well-connected; Hall Controller: Inspect if motor hall is well-connected.
25	Brake Abnormality	Inspect if brakes original state before display startup.
30	Communication Abnormality	Inspect if lines are well-connected between display and controller.

8. General Setting

When the display power on, press both **+** and **-** buttons for 2 seconds to enter the setting menu. When the display is on status of general setting, press the button **⏏** for 2 seconds to quit setting menu.

8.1 Wheel Diameter Setting

Press button **+** or **-** to select the correct value to match the wheel diameter. Selectable values include: 16 inch、18inch、20 inch、22 inch、24 inch、26 inch、700C、28 inch。Default diameter is 26 inch.

Press button **⏏** to confirm the value of wheel diameter and enter next setting at the same time.

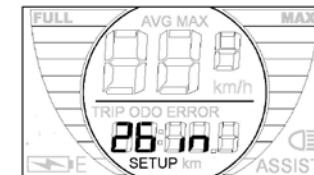

Wheel Diameter setting

8.2 Speed-limit Setting

When the running real-time speed is faster than the value of limited- speed you set, the controller will cut off the motor power

to protect the rider's safety. Limited speed default setting value is 25Km/h. the values of Limit-Speed range from 12Km/h to 40Km/h. Press **+** or **-** to select the favorite value, Press **M/C** to confirm. Then enter the next setting.



Limit Speed Setting

8.3 Backlight Contrast setting

“bL” means backlight. Level 1 is low brightness. Level 2 is the middle brightness. Level 3 is high brightness. The default level is 1. Press button **+** or **-** to modify the backlight brightness. Press button **M/C** to confirm.



Backlight Brightness setting

9. Connection layout

Following is the standard connector of display to connect the controller.



Standard Connector

Display-side terminal

Terminal of plug-in wire

Line sequence table

Line sequence	Color	Function
1	Red (VCC)	Power +
2	Blue(K)	Switch
3	Black(GND)	Ground
4	Green(RX)	Received Data
5	Yellow(TX)	Transmitted Data



Some wire use the water-proof connector, users are not able to see the inside color.

10. Barcode

The barcode is built up as follows:



KM529 = Name

000001=Sequence No.

12=Year of Production

06=Week of Production

3=Battery Voltage (2 is 24V, 3 is 36V, 4 is 48V)

1= Delivery form (1 is sample, 2 is mass production)

01=Hardware version No.

801=Software version No.

11. FAQ

Q: Why the display is not able to start up?

A: Check the connector between display and controller.

Q: How to deal with the error code?

A: Fix it to the maintenance place immediately.

12. Quality assurance and warranty scope

I Warranty

- 1) In guarantee period, display itself appears any quality problems when it is used correctly, our company will be responsible for warranty.
- 2) The warranty time is 24 months when display out of the factory.

II Other items

The following items do not belong to our warranty scope.

- 1) It can not be demolished.
- 2) The damage is caused by wrong installation or operation.
- 3) Shell is broken when display is out of the factory.
- 4) Wire is broken.
- 5) The fault or damage is caused by the force majeure (such as fire, earthquake, etc.) or natural disasters like lighting, etc.
- 6) Beyond warranty period.

13. Version changes

This operating instruction is a general-purpose version. Some of the version for the display software will be different from the specification, which should depend on the actual use version.

Popal
service@pmobility.com

Huub van Doorneweg 2
5151 DT Drunen
+31 (0) 416 205 205

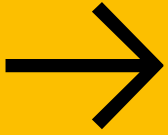

popal.com